

**2020 Utility Console**  
**901-0165A**  
(Images are Based off 901-0165B)  
**Installation Manual**

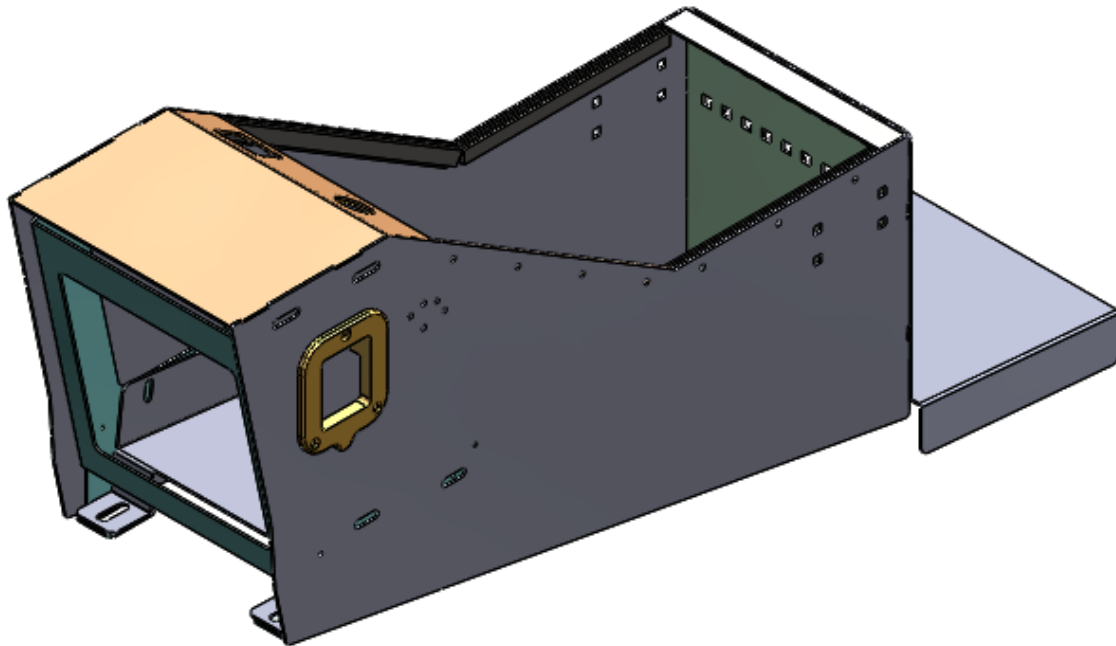

<b>Content</b>	<b>Page</b>
Assembly Overview	2-4
Installation Instructions	5-10

# Front View

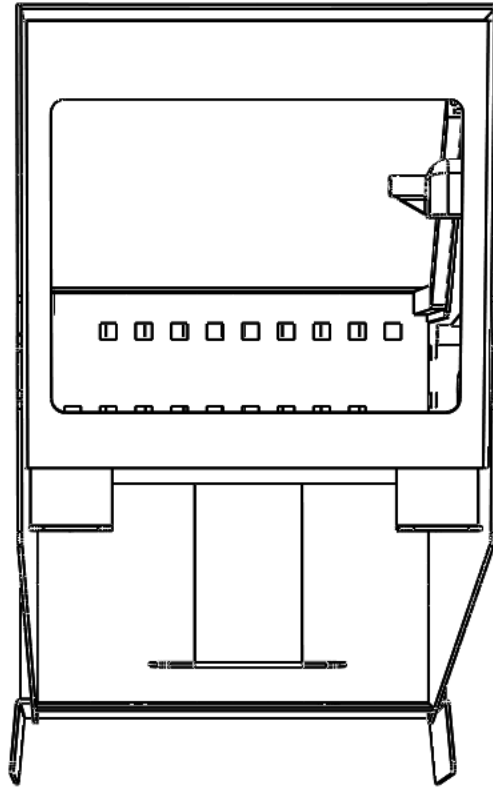

Figure 1.0

# Rear View

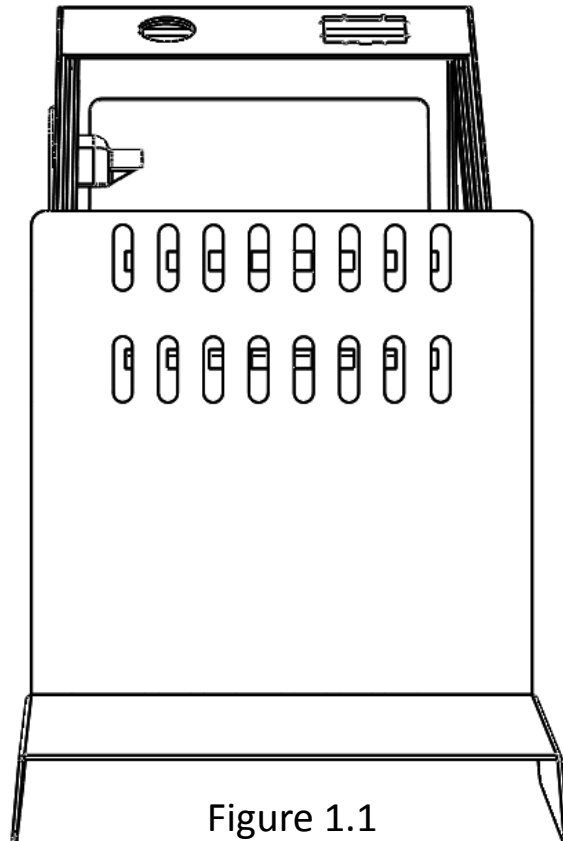

Figure 1.1

# Top View

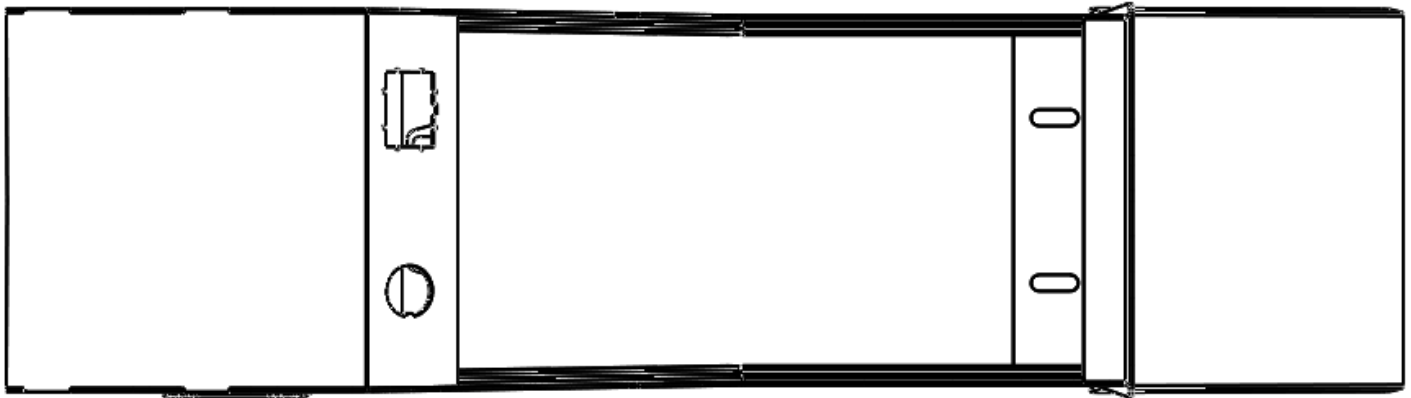

Figure 1.3

# Bottom View

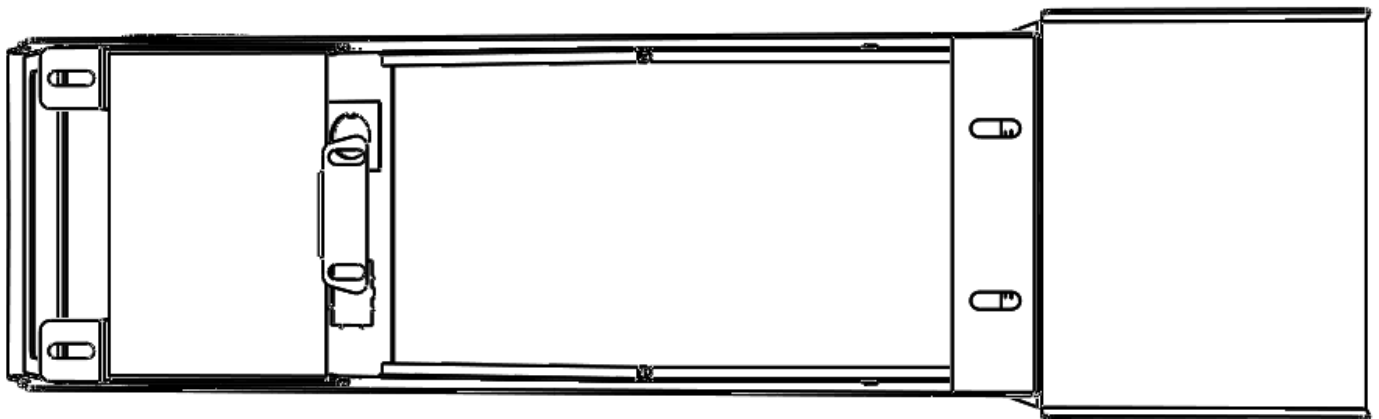

Figure 1.4

## Driver's Side View

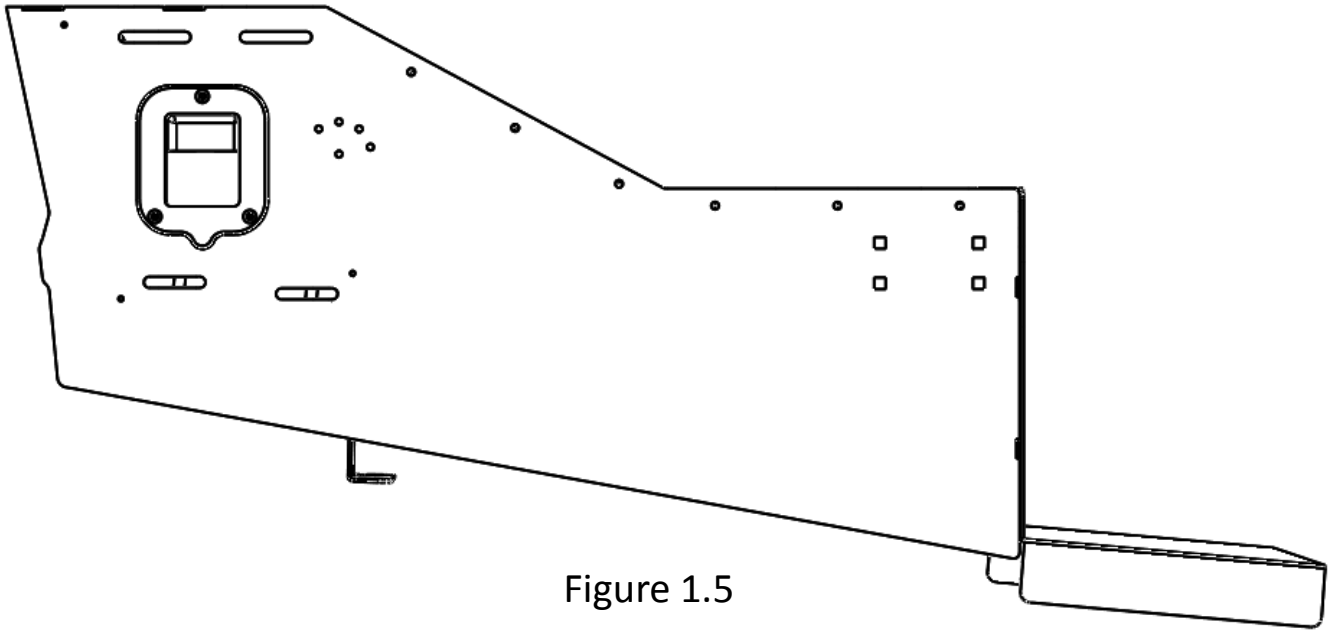

Figure 1.5

## Passenger's Side View

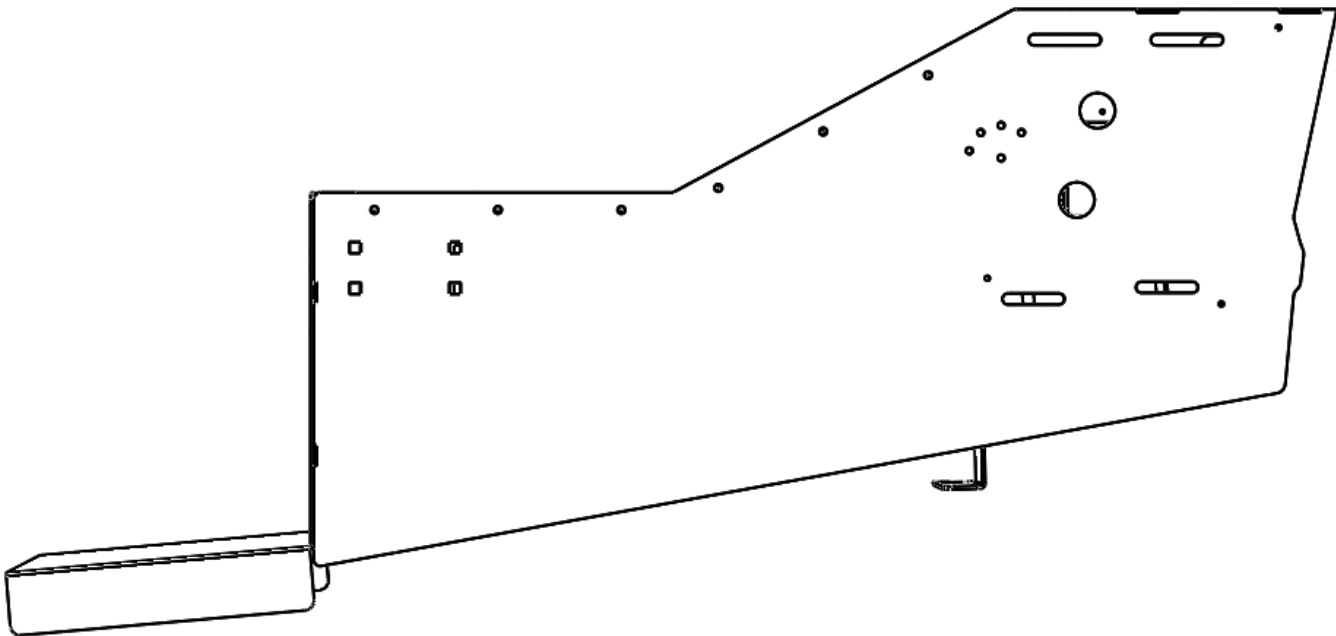

Figure 1.6

## Installation Instructions:

### Step 1

Remove the Factory Floor Plate by removing the 2 bolts located under the dash, 2 inside the cutouts on top of the plate and bolts on the back side of the plate. Retain the hardware for new consoles.



Before

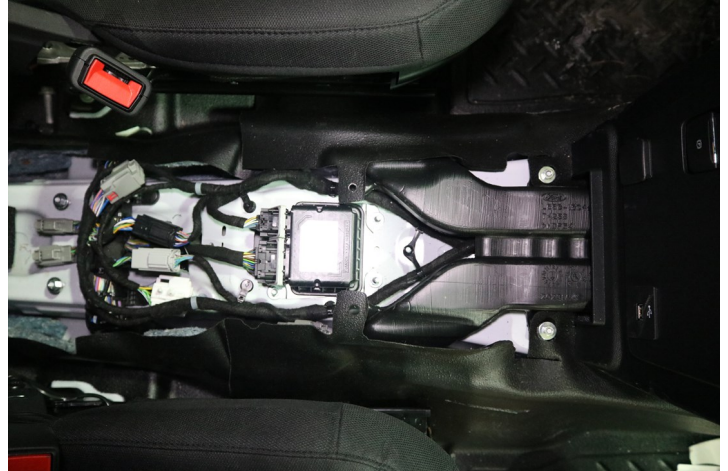

After

### Step 2

Remove the factory lower dash section by loosening the 2 screws location on either side using a 7mm socket.



**CAUTION:** The lower dash section has wiring harnesses that are attached.

### Step 3

Disconnect the three highlighted wiring harnesses located at the back of the lower dash section.

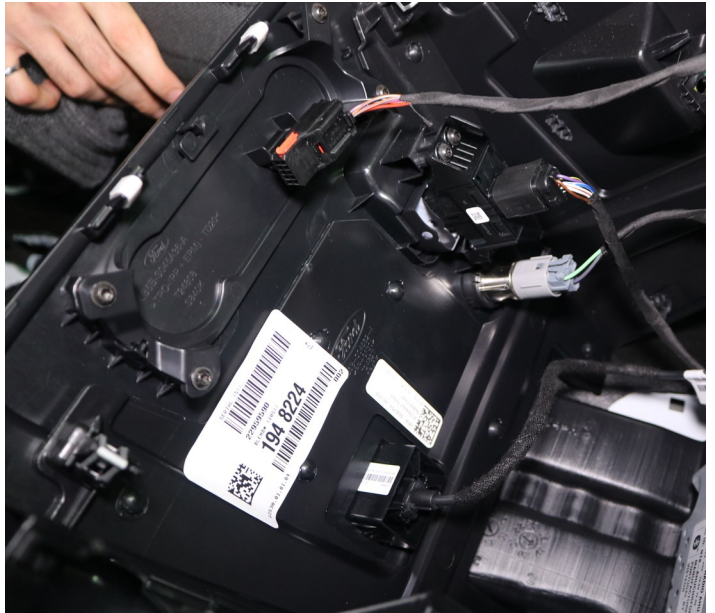

### Step 4

Remove the factory accessories from the lower dash section. Retain the hardware.

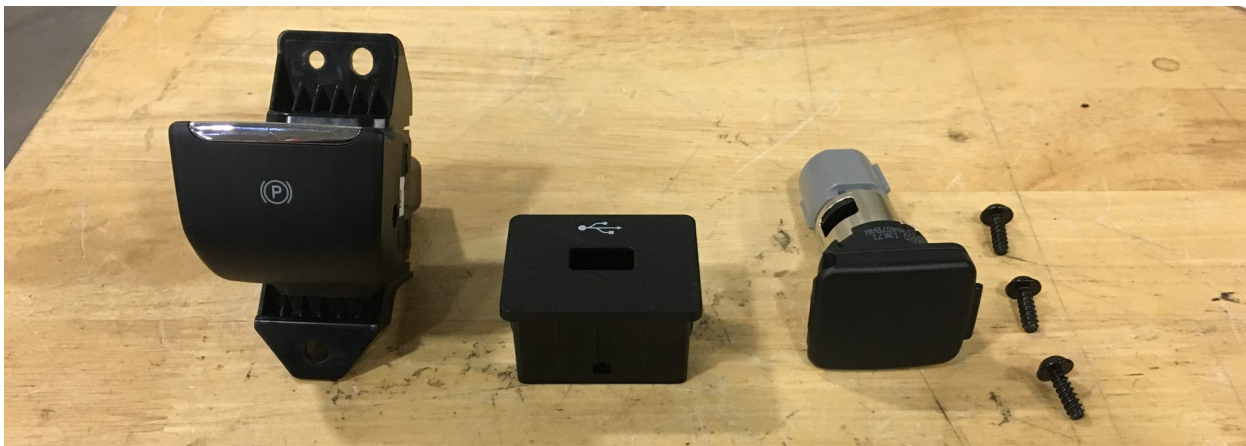

**CAUTION: DO NOT hammer or force the plastic covers. They have a pin on each side, that must be pressed using a small flat-head screwdriver when installing.**

## Step 5

Attach the lower dash section back in. Run the three harnesses through the hole that used to house the parking brake. Bolt the section back in place using the 2 bolts removed in step 1.



## Step 6

Re-install both USB port and cigarette lighter on the top of new console, as shown below in the left image.

Remove the faceplate located on the driver' side of the new console and attach the factory emergency brake switch to the back using the factory screws removed in the previous step. Re-install the faceplate into side of console.

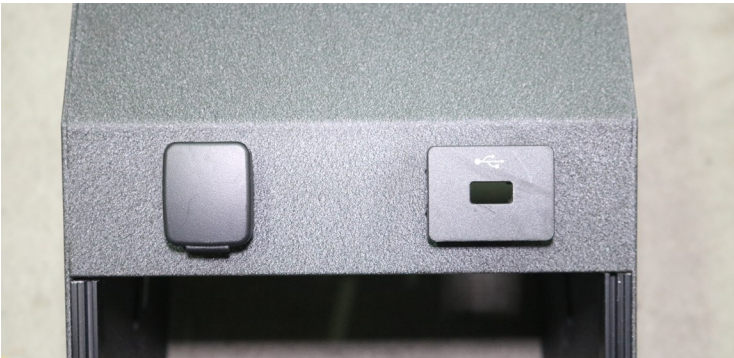

## Step 7

Detach the Console Mid Mounting Base from the console by un-fastening the nuts located on inside, retain the hardware.

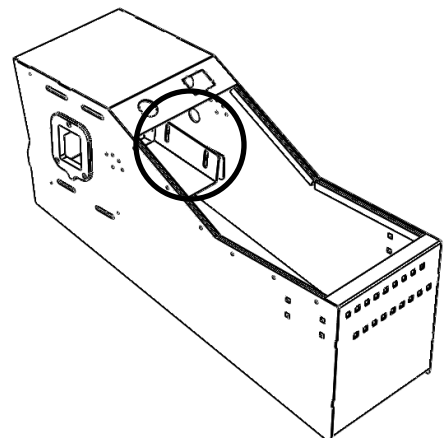

## Step 8

Remove the indicated 6 factory nuts, using a 10 mm socket. Retain the hardware for future steps.



## Step 9

Disconnect the wiring harnesses located as shown below.

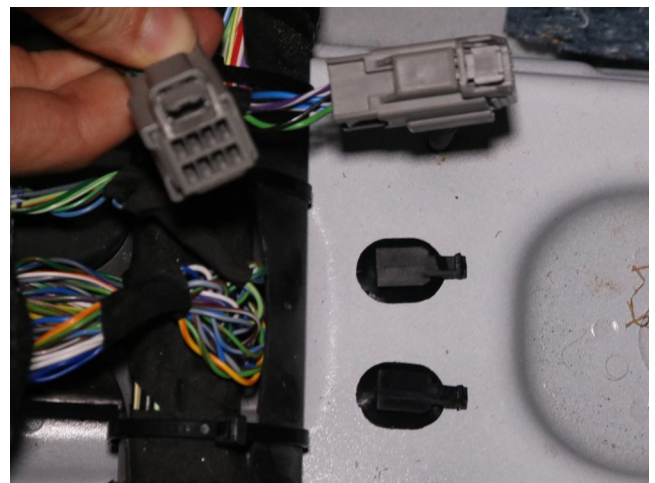



## Step 10

Mount the Console Mid Mounting Base using the nuts removed in the previous step. Ensure to apply pressure on the Console Mid Mounting Base towards the front of the vehicle while tightening down.



## Step 11

Place the new console on top of the Console Mid Mounting Base. Push the console forward tight to the dash and secure with the hardware removed in step 7. Reconnected wiring harnesses to the correct factory accessories.

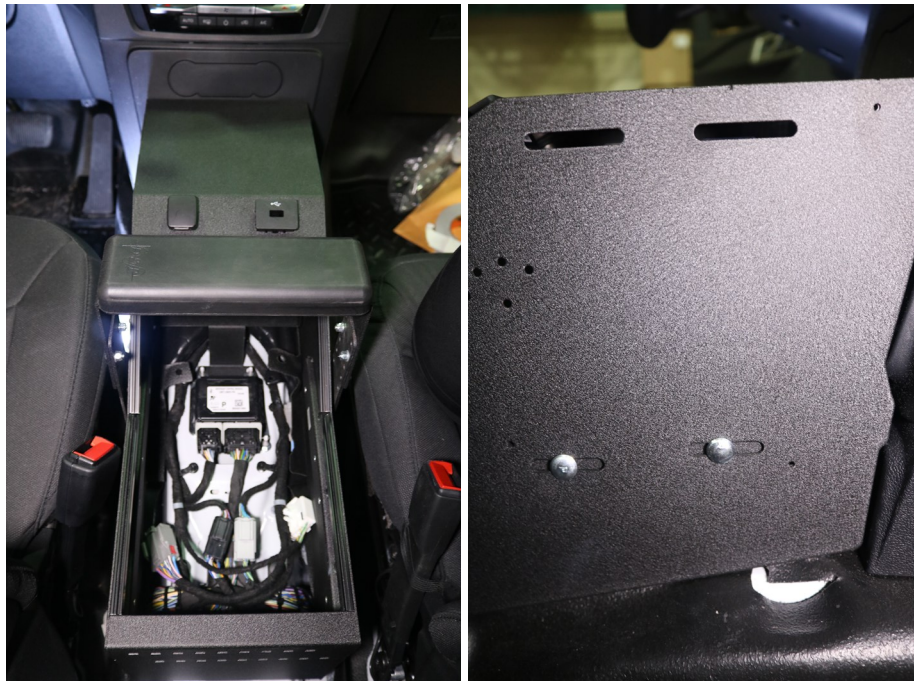

## Step 12

Attach the console rear cover plate to the back the console as shown using 5/16"-18 X 3/4" Carriage Bolt (x4), 5/16" Lock Washer (x4) and 5/16" Hex Nut (x4) in the four slots at the beginning and end of the rows. Ensure to push firmly on the rear cover plate.

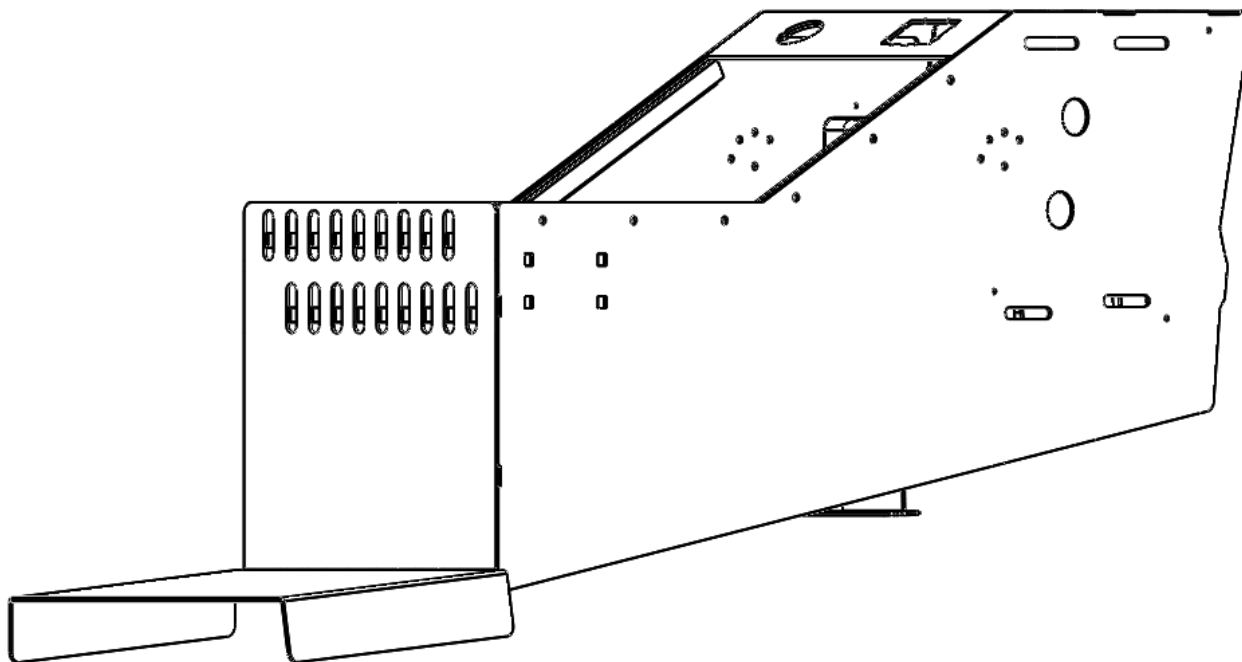

## WARRANTY

D & R Electronics warrants its new products to be free from defects in material and workmanship, under normal use and service, for a period of one year on parts replacement, and one year on labor.

This warranty applies only to original purchasers acquiring the product directly from D&R Electronics, or its authorized dealers. Warranty will not be recognized without proof of purchase or bill of sale. This warranty is not transferable.

The warranty begins on the date of delivery to the first user/purchaser. This warranty shall not apply to products which must be repaired due to normal wear and tear, negligence, improper installation, abuse, misuse, or which have been

altered or modified at a facility other than D & R Electronics, or its authorized depot center. Units proved to be defective within the warranty period, based on an examination by D&R Electronics, will be replaced or repaired at D & R Electronics' option. This warranty does not cover travel expenses or labor charges for removal or installation. Lamps, flash tubes, batteries or other items considered consumables are not covered under warranty.

This warranty is in lieu of all other express warranties. D&R Electronics makes no other warran-

## PRODUCT RETURN POLICY

In order to provide you with faster service, product returns for repair or replacement, must have a **Return Goods Authorization Number (RGA number)**. Please contact our company to obtain a RGA number before you return the product to D & R ELECTRONICS. Write the RGA number clearly on the package. Be sure you use sufficient packing materials to avoid damage to the product being returned while in transit.

D & R ELECTRONICS assumes no responsibility or liability for expenses incurred for the removal and/or the installation of products requiring service and/or repair. Repairing or replacing product is at the

### D&R ELECTRONICS Co. LTD.

#### CANADA

8820 George Bolton Pkwy.

Bolton, Ontario L7E 2Y4

Tel.: (905)951-9997

Fax: (905)951-0019

#### USA

2299 Kenmore Ave

Building #3, Doors 11-14

Buffalo, NY, 14207

Toll Free 1-800-538-7338

[www.dandrelectronics.com](http://www.dandrelectronics.com)