

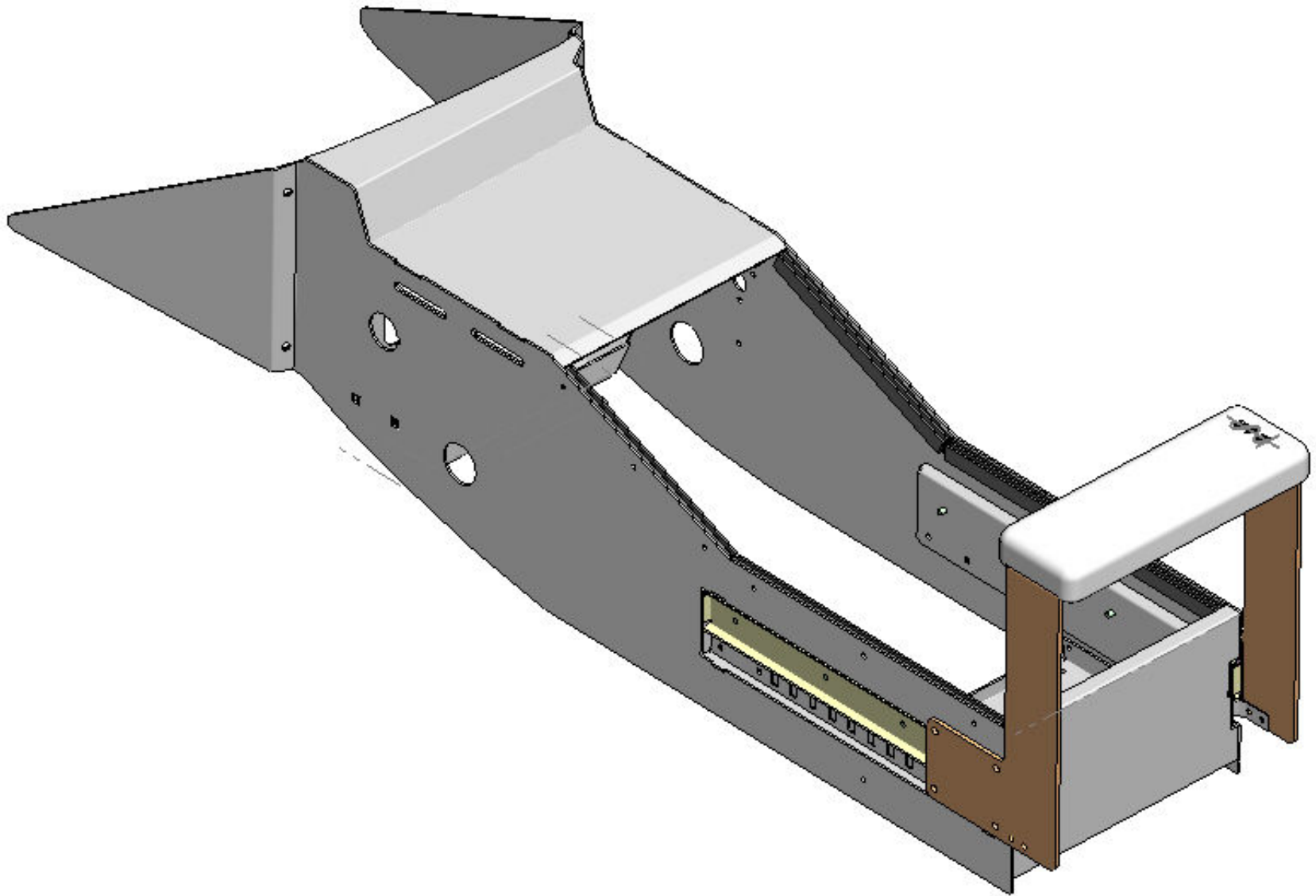

ELECTRONICS CO. LTD.
EMERGENCY VEHICLE SOUND, LIGHTING & EQUIPMENT

**CONSOLE C
DODGE CHARGER 2011
Installation Instructions
901-0073A**



Parts List

Part #	Description	Qty
901-0073A	CHARGER 2011 CONSOLE C	1
801-0383A	DS CONSOLE WING	1
801-0384A	PS CONSOLE WING	1

Hardware List

Line #	Description	Qty
1	SCREW #10-32	4
2	WASHER #10	4
3	# 6 TAP SCREW BLACK FOR FACEPLATES	10

Installation Instructions

Step 1

Remove plastic cover and factory floor plate by loosening the 4 nuts on floor plate.

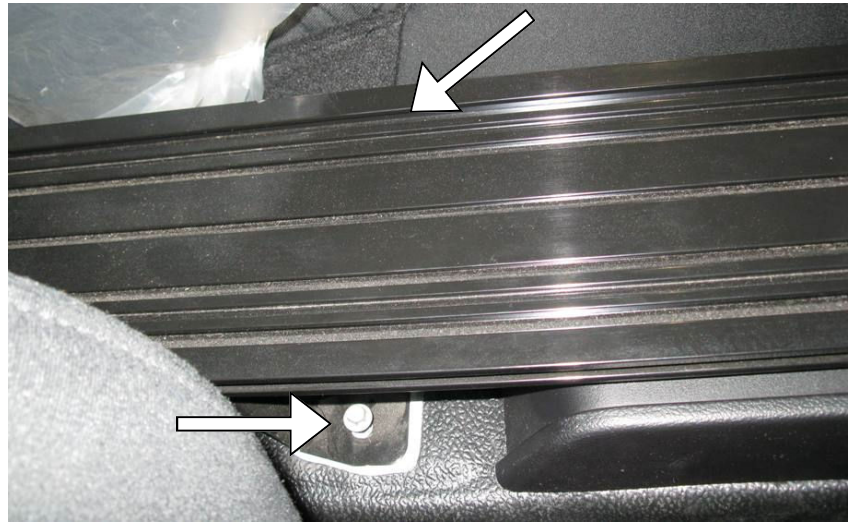
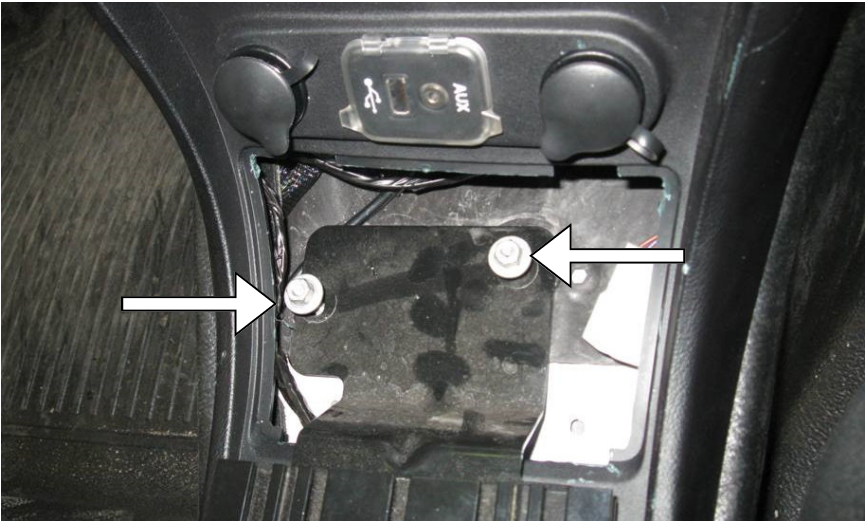

Step 2

Remove console and plastic and flip it over.



Step 3

Remove two clips shown and get the console out of the vehicle. (1 connected to Antenna harness & 1 to Aux/USB socket)

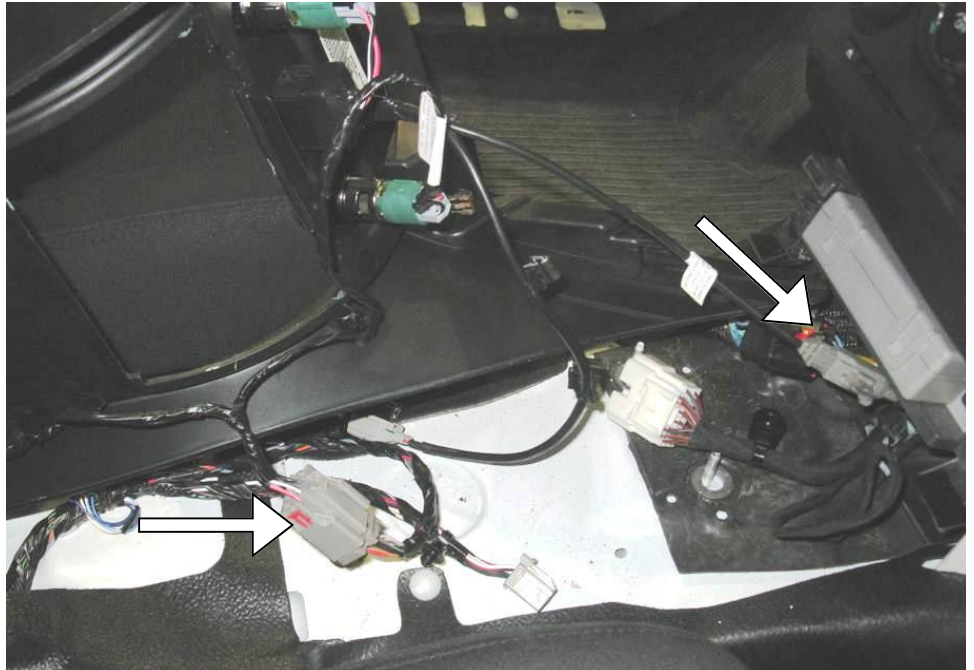

Step 4

Remove Key Antenna, 12V outlets and USB/Aux outlet. Remove the harness completely. Retain screws for Step 5.

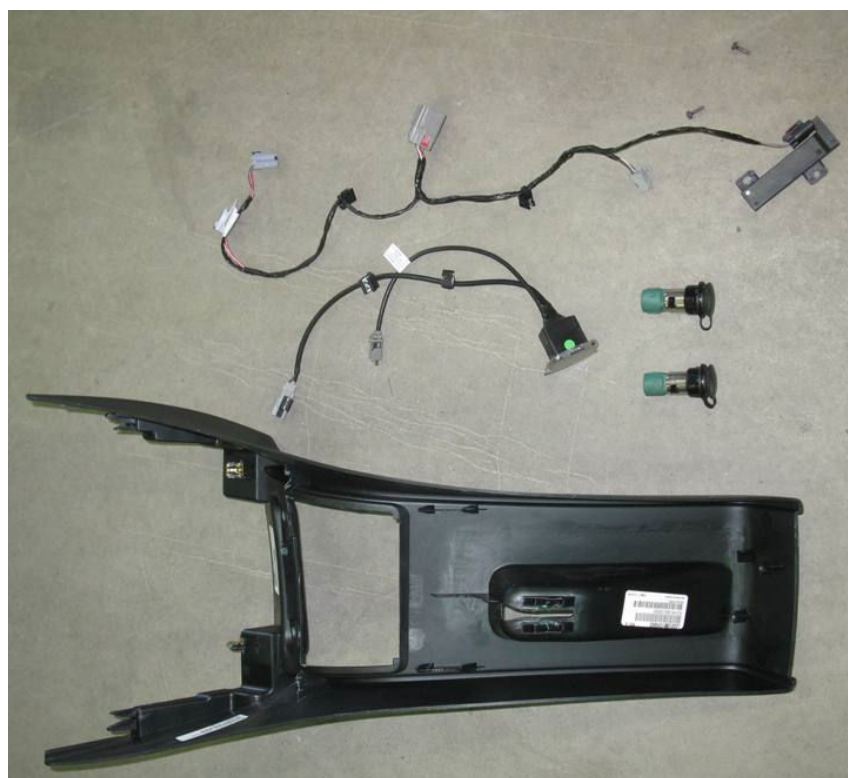

Step 5

Install antenna on console using screws obtained from Step 4. Install sockets and outlets as shown.

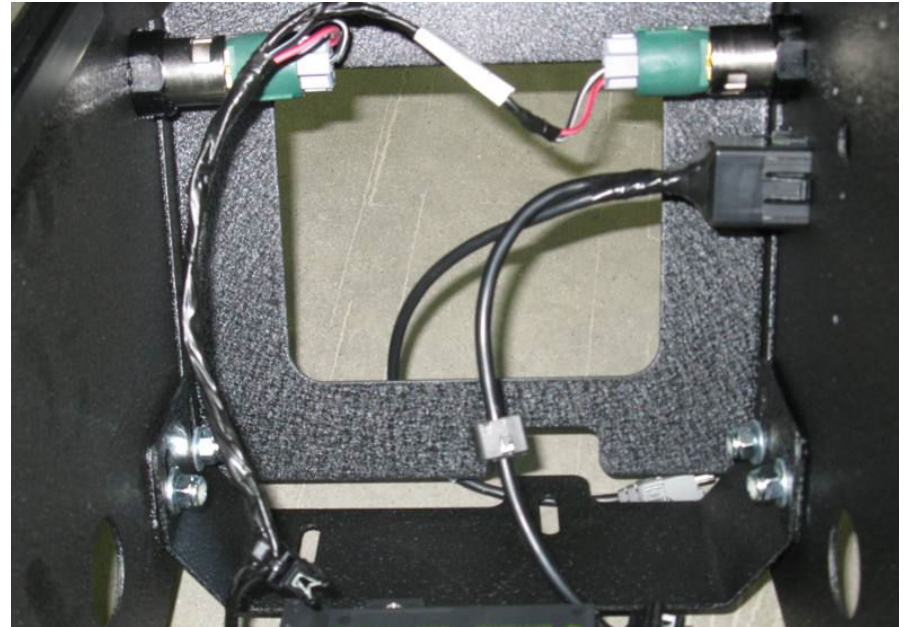
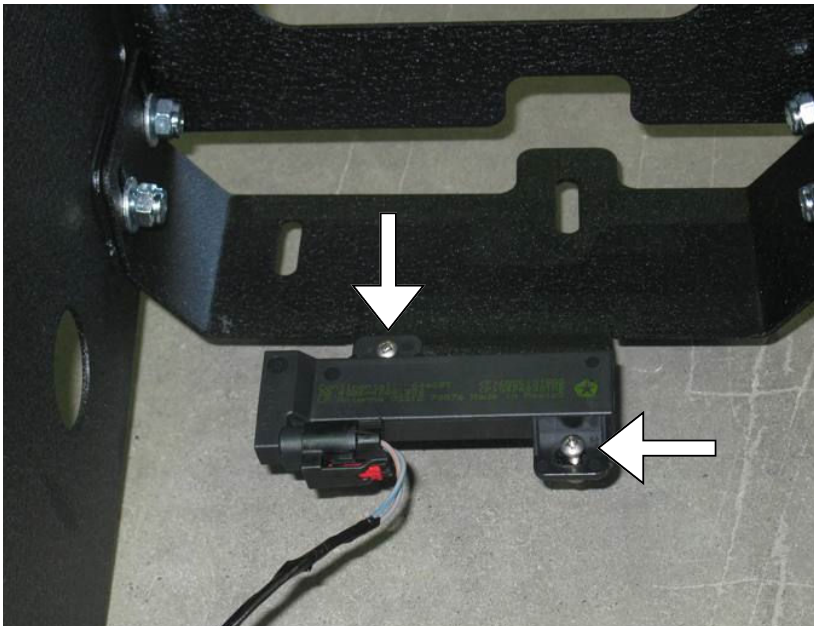

Step 6

Place console in the vehicle and secure. Reconnect harnesses.



Step 7

Install DS & PS wings using 2 sets each of hardware, line no. 1 & 2. Adjust the height of console and tighten all nuts to secure.

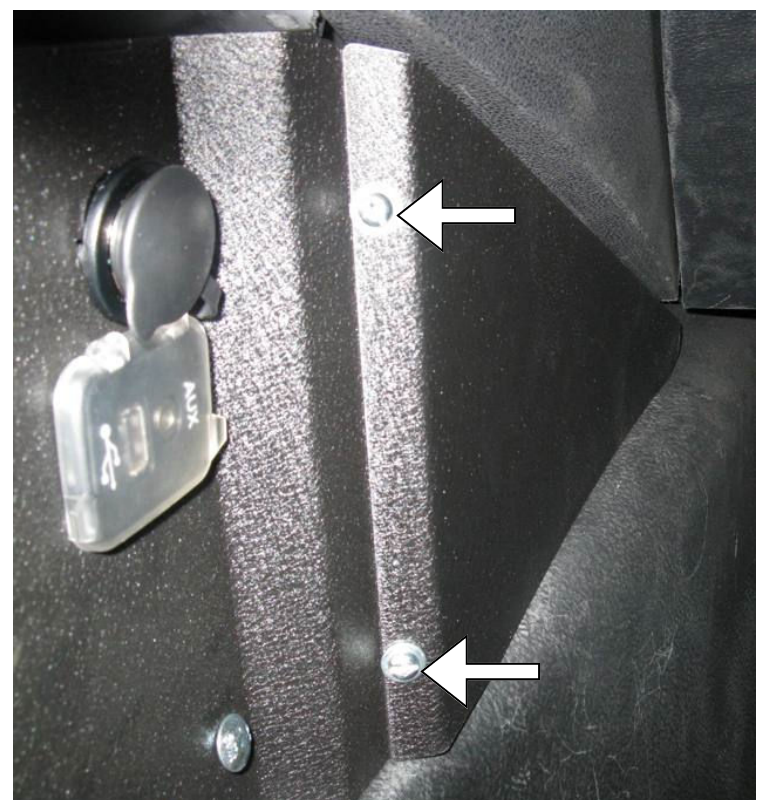
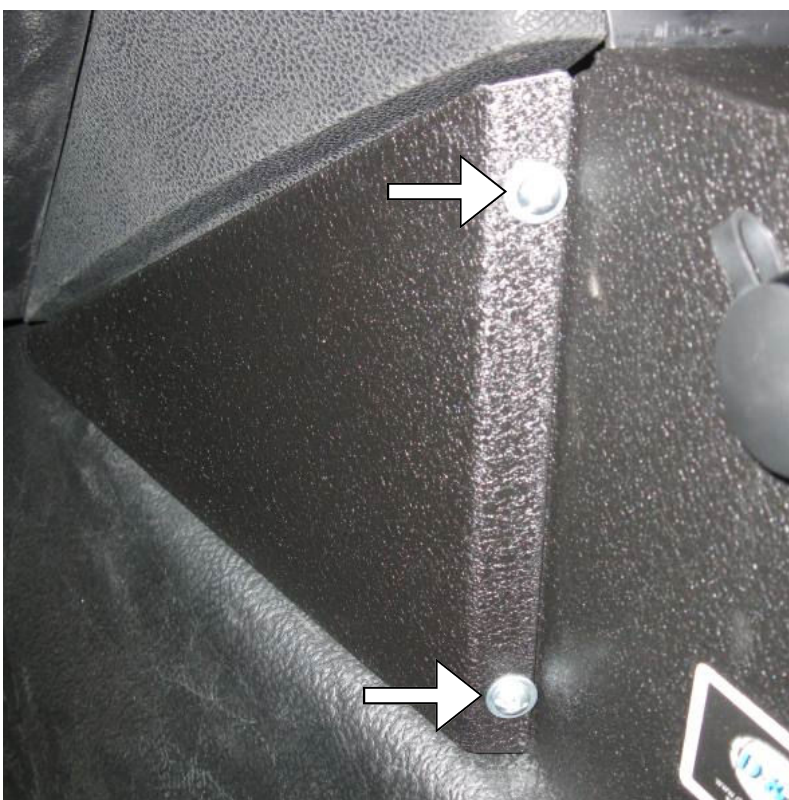

You have now completed installing the console.

WARRANTY

D & R Electronics warrants its new products to be free from defects in material and workmanship, under normal use and service, for a period of one year on parts replacement, and one year on labor.

This warranty applies only to original purchasers acquiring the product directly from D&R Electronics, or its authorized dealers. Warranty will not be recognized without proof of purchase or bill of sale. This warranty is not transferable.

The warranty begins on the date of delivery to the first user/purchaser. This warranty shall not apply to products which must be repaired due to normal wear and tear, negligence, improper installation, abuse, misuse, or which

have been altered or modified at a facility other than D & R Electronics, or its authorized depot center. Units proved to be defective within the warranty period, based on an examination by D&R Electronics, will be replaced or repaired at D & R Electronics' option. This warranty does not cover travel expenses or labor charges for removal or installation.

Lamps, flash tubes, batteries or other items considered consumables are not covered under warranty.

This warranty is in lieu of all other express warranties. D&R Electronics makes no other warranties, expressed or implied, than the express warranties contained herein.

PRODUCT RETURN POLICY

In order to provide you with faster service, product returns for repair or replacement, must have a **Return Goods Authorization Number (RGA number)**. Please contact our company to obtain a RGA number before you return the product to D & R ELECTRONICS. Write the RGA number clearly on the package. Be sure you use sufficient packing materials to avoid damage to the product being returned while in transit.

D & R ELECTRONICS assumes no responsibility or liability for expenses incurred for the removal and/or the installation of products requiring service and/or repair. Repairing or replacing product is at the discretion of D & R ELECTRONICS.

D&R ELECTRONICS Co. LTD.

CANADA
8820 George Bolton Pkwy.
Bolton, Ontario L7E 2Y4

Tel.: (905)951-9997
Fax: (905)951-0019

USA
2299 Kenmore Ave.
Building #3, Doors 11-14
Buffalo,, NY 14207

Toll Free 1-800-538-7338

www.dandrelectronics.com